

eZyvalve[®]4

ALL IN ONE VALVE BOX WITH 4 VALVES

INSTALLATION GUIDE



- * 3/4" BSP threads
- * Compact size
- * Water resistant
- * Patented design
- * Lid with o-ring seal
- * UV stable materials
- * No internal pipe connections
- * High impact resistant materials
- * Above or below ground installation



ANTELCO
Putting water where it counts![®]

eZyvalve[®]4

eZyvalve [®] 4 Pressure Loss	
Flow Rate (L/min)	Pressure Loss (kPa)
10	30
15	63
20	108
25	165
30	231

Operating Specifications

Flow: 10 L/min to 30 L/min

Pressure: 30 kPa to 1250 kPa

Ambient Temperature: 2°C to 60°C

Electrical: 24Vac, inrush current 320 mA,
holding current 260 mA @ 50 Hz

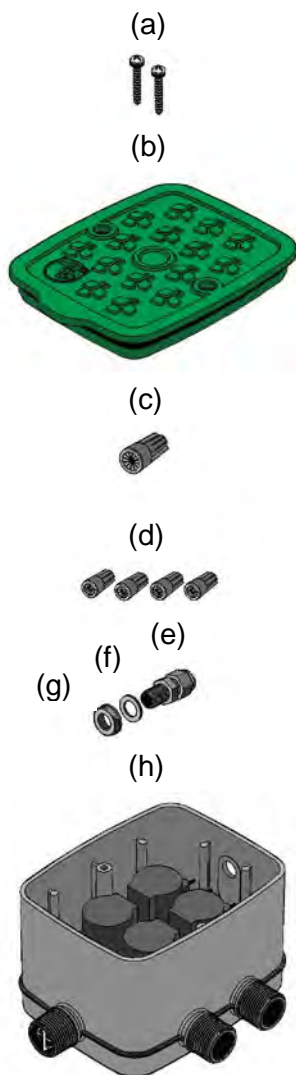

Introduction

Please read and understand instructions fully before beginning installation of your eZyvalve[®]4.

The eZyvalve[®]4 must be connected to a 24Vac irrigation controller. eZyvalve[®]4 is suitable for use in damp, wet and rainy conditions. eZyvalve[®]4 is not to be used for continuously submerged applications.

When designing your irrigation system, refer to your local building codes for plumbing and electrical requirements.

If the water supply is non-potable, you may need filtration. Contact your local irrigation contractor / supplier for further advice.

Flushing the mains before connection and the irrigation lines after connection minimises the risk of small particles in the water affecting the performance of the valves and downstream micro irrigation components.

In freezing climates, winterisation is needed to remove water from the irrigation system to ensure that freezing and the expansion of water do not damage the components. This may be accomplished by draining the system.

eZyvalve[®]4 contents:

- (a) 2 stainless steel screws with sealing washers
- (b) 1 lid with "O" ring
- (c) 1 Dryconn[®] electrical wire connector (large)
- (d) 4 Dryconn[®] electrical wire connectors (small)
- (e) 1 cable gland suitable for 0.5 mm² (#20 AWG) 5-core multi-strand direct burial cable
- (f) 1 washer for cable gland
- (g) 1 hexagonal nut for cable gland
- (h) 1 eZyvalve[®]4 valve box with 4 inbuilt 24Vac solenoid valves with 180 mm cables

You will need:

- * A 24Vac programmable irrigation controller
- * A suitable length for your application of 0.5 mm² (#20 AWG) 5-core multi-strand direct burial controller cable
- * Plumbers thread-seal tape
- * Wire cutters and / or wire strippers
- * Screw drivers (to suit controller screws and cross / slotted head screws for valve box lid)

eZyvalve[®]4

Installation instructions

Water Connections

Note: it may be easier to pre-wire the controller cable (instruction 2-5) before installing the eZyvalve[®]4 in the ground.

1. Connect the water supply to the $\frac{3}{4}$ " BSP tapered inlet thread of the eZyvalve[®]4 valve box (h). Use only plumbers thread tape to seal threads - do not use pipe sealant paste. Connect your irrigation lines to each of the four $\frac{3}{4}$ " BSP parallel threaded outlets. Cap unused outlets. (Fig 1)

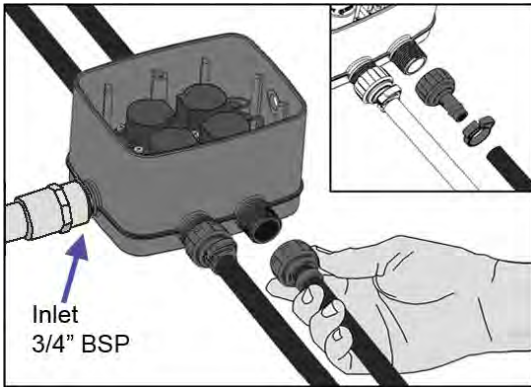

(Fig 1)

Wiring Connections

2. Assemble the cable gland (e) by removing the hexagonal nut (g) and pushing the cable gland (e) through the hole in the end of the eZyvalve[®]4 box (h), with the washer (f) on the outside of the box. Replace the hexagonal nut (g) on the inside of the box and tighten. (Fig 2)

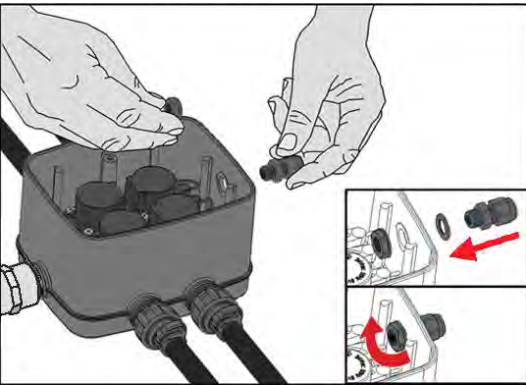

(Fig 2)

3. Loosen the hexagonal sealing nut on the outside of the cable gland (e) and push the controller cable through the gland, allowing enough cable inside for connection to the solenoid leads. Ensure the outer sheathing of the cable penetrates through the cable gland. Strip 75 mm of outer sheath from the controller cable ensuring you do not damage the inner cores. Next, strip 15 mm of insulation from the end of each inner wire and align any frayed strands. (Fig 3)

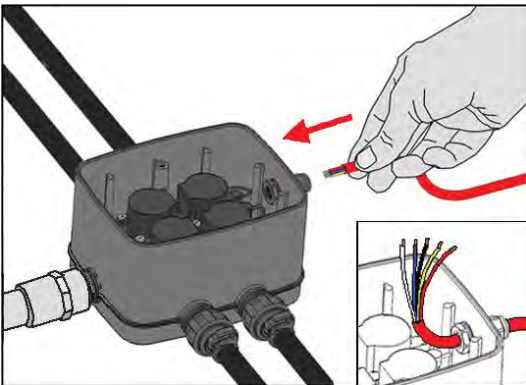

(Fig 3)

4. Use the large black and grey wire connector (c) to join one wire from each solenoid to the common (black) wire from the controller (it does not matter which of the two wires on each solenoid is connected to the common). Place the wires to be joined together, with the ends of the insulation even. Twist the connector clockwise onto the wires, pushing firmly until hand tight. Do not over tighten. While tightening, wipe sealant in and around the wires and the opening. **Do not reuse wire connectors.** (Fig 4 and Fig 6 wiring diagram)

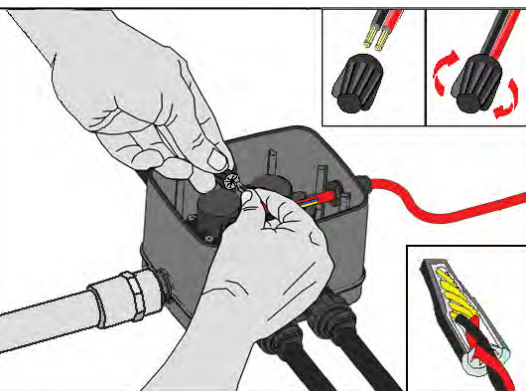

(Fig 4)

5. Using one of the four smaller black and white wire connectors (d), connect the second wire from solenoid valve #1 to one of the remaining controller cable wires (eZyvalve[®]4 solenoid valves are numbered 1 to 4 in line with the outlet, inside the box). Repeat with the other connectors until all the solenoids have been connected. By checking the wire colour at your irrigation controller, you can ensure that the valve numbering sequence matches that of the controller.

(continued overleaf)

eZyvalve[®]4

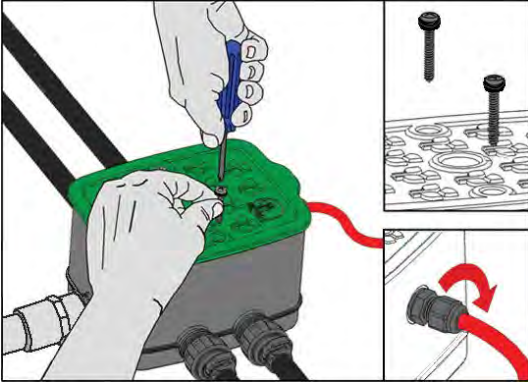

(Fig 5)

6. Pull excess controller cable back through the cable gland to adjust for excess wire in the valve box and tighten the hexagonal sealing nut on the outside of the valve box. Ensure a small length of the outer sheathing of the cable still penetrates through the cable gland.

7. Arrange connectors and wires to allow proper closure of the lid. Push the lid (b) in place, making sure the "O" ring seal and seat are clean to ensure sealing. Insert and tighten the lid screws (a), checking that the rubber washers are in place on the screws to maintain a seal. (Fig 5)

Controller Connections

Refer to your 24 Vac irrigation controller instructions to connect the controller cable to the controller terminals. Before making these connections, ensure power to controller is OFF.

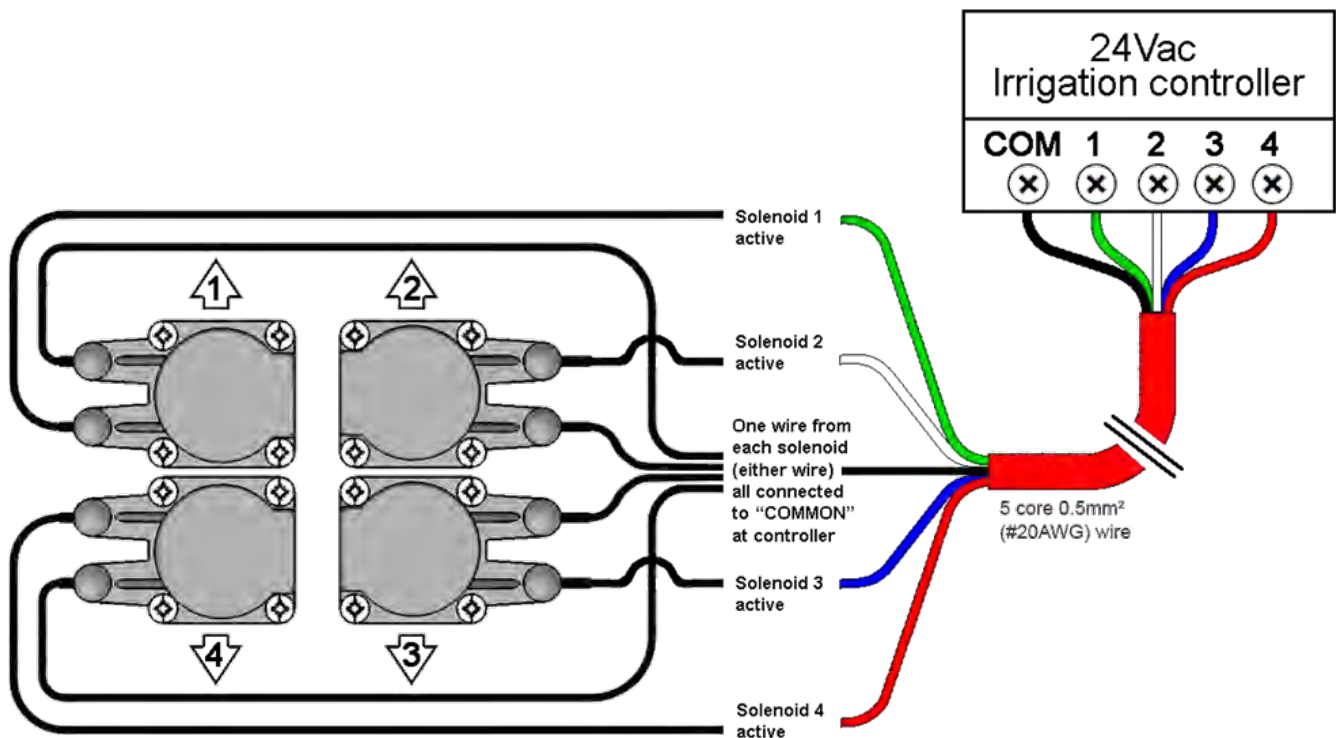

(Fig 6 wiring diagram)



Australia

Scan here with your smart phone!



Europe